

aquatica®

*Function, Form & Fashion*



*Fusion & Dream Series*

*Bathtub*

Operating Manual

# WARNING

1. READ AND FOLLOW ALL INSTRUCTIONS
  2. WARNING: When using electrical products, basic precautions should always be followed, including the following:
  3. DANGER: To reduce the risk of injury, do not permit children to use this unit unless they are closely supervised at all times.
  4. Use this unit only for its intended use as described in this manual. Do not use attachments not recommended by the manufacturer.
  5. Never drop or insert any object into any opening.
  6. Do not operate this unit without the guard over the suction fitting.
  7. DANGER: RISK OF ELECTRIC SHOCK. The unit must be connected only to a supply circuit that is protected by a ground-fault circuit-interrupter (GFCI) or Earth-Leakage Circuit-Breaker (ELCB). Such a GFCI should be provided by the installer and should be tested on a routine basis. To test the GFCI, push the test button. The GFCI should interrupt power. Push the reset button. Power should be restored. If the GFCI fails to operate in this manner, the GFCI is defective. If the GFCI interrupts power to the bathtub without the test button being pushed, a ground current is flowing, indicating the possibility of an electric shock. Do not use this hydromassage bathtub. Disconnect the hydromassage bathtub and have the problem corrected by a qualified service representative before using.
  8. WARNING: RISK OF ELECTRIC SHOCK. A licensed electrician should make all electrical connections. Disconnect power before servicing.
  9. WARNING: RISK OF INJURY OR PROPERTY DAMAGE. Please read all instructions thoroughly before beginning installation, including the following requirements.
  10. Follow all local plumbing and electrical codes.
  11. INSTALL TO PERMIT ACCESS FOR SERVICING.
  12. (For permanently connected units) A green-colored terminal (or a wire connector marked G, GR, Ground, or Grounding) is provided within the terminal compartment. To reduce the risk of electric shock, connect this terminal or connector to the grounding terminal of your electric service or supply panel with a conductor equivalent in size to the circuit conductors supplying this equipment. A pressure wire connector is provided on the exterior of the pump or control within this unit to permit connection of a bonding conductor between this unit and all other exposed metal in the vicinity, as needed to comply with local requirements.
- GROUNDING IS REQUIRED.** The unit must be installed by a qualified service representative, and grounded. Building materials and wiring should be routed away from the pump body and other heat-producing components of the unit.

## IMPORTANT PRODUCT INFORMATION

### PRODUCT NOTICES

**WARNING:** Unauthorized modification may cause unsafe operation and poor performance of the bath. Do not relocate the pump, or make other modifications to the circulating system, as this could adversely affect the performance and safe operation of your bath. Aquatica Plumbing Group Inc. shall not be liable under its warranty or otherwise for personal injury or damage caused by any such unauthorized modification.

### PRODUCT INSPECTION

Carefully unpack the product and inspect the unit for damage. Return the unit to the carton during construction to prevent damage.

### FACTORY-ASSEMBLED FEATURES

Factory installed components include components like pump, blower, level sensors, in-line heater, submerged chromotherapy lights, keypad and diverter. The pump and piping are factory-assembled.

### CONNECTIONS AND SERVICE ACCESS

**NOTICE:** For built-in and corner bathtubs provide unrestricted service access to the pump, heater and control box. Provide unrestricted service access to the pump, blower, in-line heater, adjustable feet, and For built-in bathtubs you must construct an access panel to provide sufficient clearance for servicing the pump, inline heater, and control box. The access panel must be located immediately next to the pump and in line heater. Study the roughing-in information.



## ELECTRICAL REQUIREMENTS

1. **DANGER: RISK OF ELECTRIC SHOCK.** The installation must have one (1) Class A Ground Interrupters (GFCI's) or Earth-Leakage Circuit Breakers (ELCB's). The GFCI/ELCB protects against line shock hazard. **Use a 208-240V, 20A, 50/60 Hz OR Use a 110V, 20A, 50/60 Hz dedicated service to wire the control system.**
2. **GROUNDING IS REQUIRED.** The unit should be installed by a qualified service representative and grounded.
3. Installation instructions shall identify fittings, such as brackets or hangers, that are necessary to the intended mounting of the unit.
4. The minimum structural strength required for the supporting surface for the unit. Need to provide rough in instructions to review for compliance.
5. Instructions shall indicate that building materials and wiring should be routed away from the pump body and other heat producing components.
6. **INSTALL TO PERMIT ACCESS FOR SERVICING**
7. An equipment bonding terminal is provided in the field wiring compartment. To reduce the risk of electric shock, this terminal must be connected to the bonding means provided in the electric supply panel with a conductor equivalent in size to the circuit conductors supplying this equipment.

# *Fusion & Dream Series Bathtub* Operating Manual

8. INSTALL THIS UNIT IN ACCORDANCE WITH THE CANADIAN ELECTRICAL CODE, PART I. and INSTALLER CONFORMEMENT AU CODE CANADIEN DE L'ELECTRICITE, PREMIERE PARTIE (CSA C22.2 No. 218.2 com compliance).

Your physiological response to hot water is subjective and depends on your age, health, and medical history. If you don't know your tolerance to hot water, or if you get a headache, or become dizzy or nauseous when using your hot tub, get out and cool off immediately.



## WARNING

### ELECTRICAL REQUIREMENTS

IMPORTANT! SAFETY INSTRUCTIONS / INSTRUCTIONS IMPORTANTES RELATIVES A LA SECURITE

READ, FOLLOW ALL INSTRUCTIONS / LIRE ET SUIVRE TOUTES LES INSTRUCTIONS  
SAVE THESE INSTRUCTIONS / CONSERVER CES INSTRUCTIONS

1. **WARNING: RISK OF ACCIDENTAL INJURY OR DROWNING.** Children should not use hydromassage bathtub without adult supervision. / **AVERTISSEMENT. RISQUE DE BLESSURE ET DE NOYADE.** Ne pas laisser un enfant utiliser la cuve a remous en l'absence d'un adulte.
2. **WARNING: RISK OF ACCIDENTAL INJURY OR DROWNING.** Do not use hydromassage bathtub unless all suction guards are installed to prevent body and hair entrapment. / **AVERTISSEMENT. RISQUE DE BLESSURE ET DE NOYADE.** Pour éviter le happement de membres ou de cheveux, ne pas utiliser la.
3. **WARNING: To avoid injury, exercise care when entering or exiting the hydromassage bathtub.** / **AVERTISSEMENT.** Pour eviter les blessures, user de prudence en entrant dans la cuve a remous et en la quittant.
4. **WARNING: RISK OF ACCIDENTAL INJURY OR DROWNING.** Do not use drugs or alcohol before or during the use of a hydromassage bathtub equipped with heater to avoid unconsciousness and possible drowning. / **AVERTISSEMENT. RISQUE DE BLESSURE ET DE NOYADE.** Ne pas prendre de médicament ni consommer d'alcool lorsqu'on utilise une cuve à remous chauffée ou avant d'y entrer afin d'éviter l'évanouissement et le risque de noyade.
5. **WARNING: RISK OF FETAL INJURY.** Pregnant or possibly pregnant women should consult a physician before using a hydromassage bathtub equipped with heater. / **AVERTISSEMENT. DANGER POUR LE FOETUS.** Les femmes enceintes, que leur grossesse soit confirmée ou non, devraient consulter un médecin avant d'utiliser une cuve à remous chauffée.
6. **WARNING: RISK OF HYPERTHERMIA AND POSSIBLE DROWNING.** Do not use a hydromassage bathtub equipped with heater immediately following strenuous exercise. / **AVERTISSEMENT. RISQUE D'HYPERTHERMIE ET DE NOYADE.** Ne pas utiliser une cuve à remous chauffée après un exercice intense.
7. **WARNING: RISK OF ELECTRIC SHOCK.** Do not permit electric appliances (such as a hair dryer, lamp, telephone, radio, or television) within 1.5 m of this hydromassage bathtub. / **AVERTISSEMENT. RISQUE DE CHOC ELECTRIQUE.** Ne pas placer d'appareils electriques (luminaire, téléphone, radio, televiseur, etc.) a moins de 1.5 m de cette cuve a remous.

8. CAUTION: Test the ground fault circuit interrupter protecting this appliance periodically in accordance with the manufacturer's instructions. / ATTENTION. Verifier regulierement le fonctionnement du disjoncteur de fuite a la terre conformement aux instructions du fabricant.

9. WARNING: RISK OF HYPERTHERMIA AND POSSIBLE DROWNING. Water temperature in excess of 38 °c can be injurious to your health. check and adjust water temperature before use. / AVERTISSEMENT. RISQUE D'HYPERTHERMIE ET DE NOYADE. Une température d'eau supérieure à 38 °c peut présenter un risque pour la santé. vérifier et régler la température de l'eau avant d'utiliser la cuve .

10. WARNING: RISK OF HYPERTHERMIA. People using medications and/or having an adverse medical history should consult a physician before using a hydromassage bathtub equipped with heater. / AVERTISSEMENT. RISQUE D'HYPERTHERMIE. Les personnes qui prennent des médicaments ou qui ont des problèmes de santé devraient consulter un médecin avant d'utiliser une cuve à remous chauffée.



**CAUTION**



**DANGER**

Since your hot tub can be set to reach temperatures of 40°C (104° F), users should be aware that extended submersion in water that exceeds normal body temperature can lead to hyperthermia.

The causes, symptoms and effects of hyperthermia may be described as follows:

Hyperthermia occurs when the internal temperature of the body reaches several degrees above the normal body temperature of 37°C (98.6°F). The symptoms of hyperthermia include drowsiness, lethargy, and an increase in the internal temperature of the body.

**The effects of hyperthermia include:**

- Unawareness of impending hazard
- Failure to perceive heat
- Failure to recognize the need to exit the hot tub
- Physical inability to exit the hot tub
- Fetal damage in pregnant woman
- Unconsciousness resulting in the danger of drowning

If you sense any of the symptoms of hyperthermia, safely exit the hot tub immediately.

The use of alcohol, drugs or medication can significantly increase the risk of fatal hyperthermia.

#### BEFORE USING THE BATHTUB

Read these before using your new bathtub. They will provide you with useful tips to use it safely with maximum benefit.

##### Notable unique features in your bathtub:

- **Concealed overflow (applies to all Dream series bathtubs)** - there is a concealed overflow loop installed and it works exactly like I pointed out. The opening is inside the channel and it goes up to the prescribed water level, then loops back down and connects to the waste pipe below the drain valve. The working principle is based on connected vessel law from physics

# Fusion & Dream Series Bathtub

## Operating Manual

- **Autofill** - (applies to all Dream series bathtubs) if equipped with this feature the bath will fill itself to the prescribed level.
- **Turbo massage** - the same jets are simultaneously fed with water and forced air from a compressor. The combination of the air and water creates a more powerful massage effect.

### USE ADVICE

- When using the bathtub, DO NOT wear loose clothing, pendant jewelry and tie up long hair to avoid the risk of becoming caught in moving parts.
- The time spent in the bathtub should never exceed 20 minutes.
- Use the whirlpool at most three times per week.
- The paving around the bathtub may become very slippery. Be careful when entering or exiting the water.

### TIME IN WATER

For a *relaxing experience*, the ideal water temperature is about 33°-37°C (91°-99°F) for a duration of about 20 minutes. In fact, a temperature equal to that of the body fosters vasodilation and muscle relaxation.

For an *energizing experience*, soak for about 10 minutes, preferably in the morning, at about 33°C (91°F).

For a *draining experience*, use the whirlpool for 5-8 minutes at a maximum of 35°-37°C (95°-99°F). After leaving the bathtub, relax for a few minutes to allow the pressure altered by the heat and massage to return to normal.

### CHROMOTHERAPY

Chromotherapy is thought to balance and harmonize energy in the body through the use of light in the form of color. Each color has a role in this process, working on different organs of the body and spiritual functions, which correlates to the East Indian concept of the seven major energy centers or chakras. The Fusion's chromotherapy color palate includes all seven rainbow hues - red, orange and yellow to green, blue, indigo, violet and white, which gently and continuously rotate through their spectrum for a sustaining and energizing effect on the whole body.

Red: dissipates the deepest fears and maintains the person well anchored to the present.

Orange: stimulates feminine creativity, optimism, and serenity.

Yellow: brings out emotions and desires, personal power and the ability to perceive the qualities and feelings of others.

Green: reawakens love and openness towards others, selflessness, inner goodness.

Blue: promotes the ability to listen to others. It is related to the expression of one's personality, creativity, imagination, relaxation.

Indigo: has the ability to broaden understanding and treat disorders that affect sensory organs.

Violet: cool color that promotes spirituality, inspiration, and imagination.

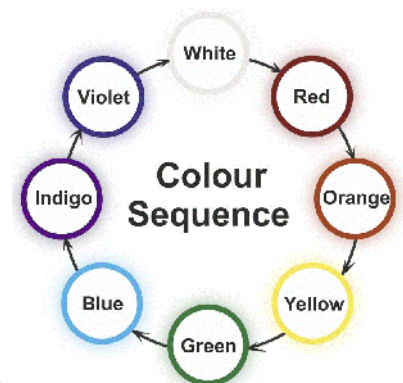

BATHTUB FUNCTIONS

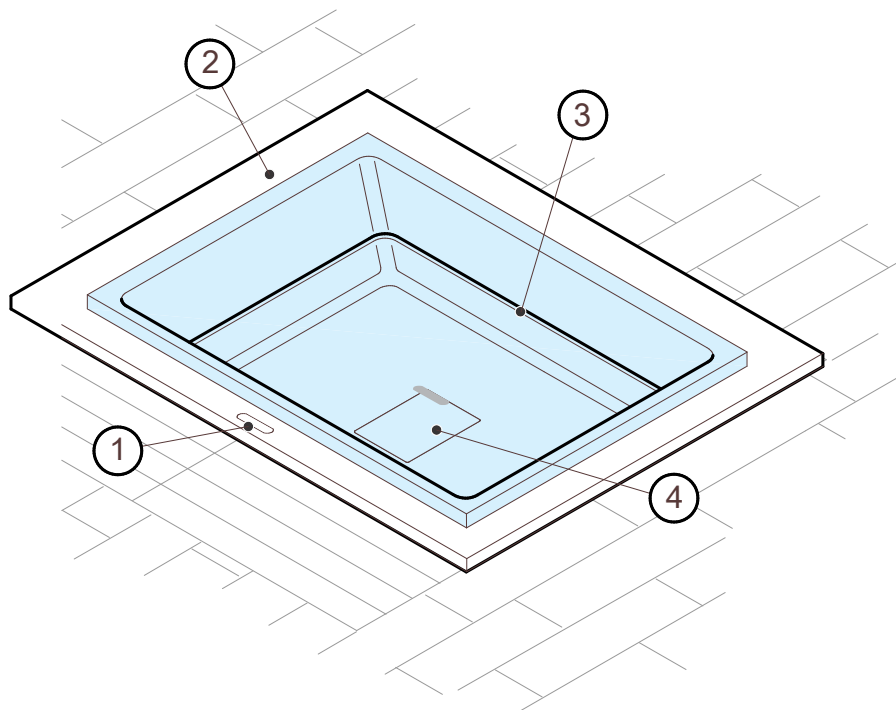

- 1 - Control panel
- 2 - Overflow edge
- 3 - Whirlpool and lightning
- 4 - Decorative drain cover

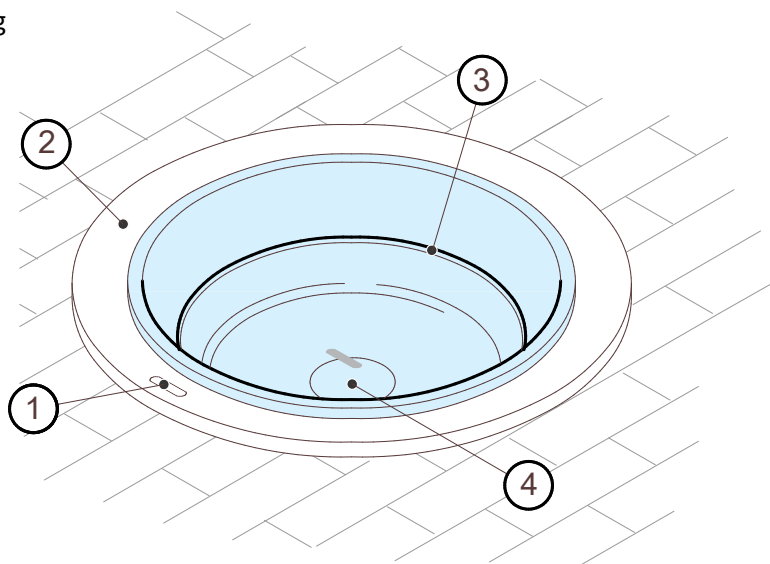

# Fusion & Dream Series Bathtub

## Operating Manual

The bathtub must ALWAYS remain connected to both the electrical grid and plumbing (filling and draining): this is necessary for filtering, cleaning the filters and maintaining the bathtub's water levels and temperature. ALWAYS cover the bathtub when inactive. This protects it from the sun's rays, prevents dirt from accumulating inside the bathtub and keeps it from losing heat, thus optimizing the efficiency of the heater.

### FILLING THE BATHTUB

Filling is carried out by following the figures on the side (follow the instructions for your keypad).

This occurs through a concealed spout in the compartment on the bottom of the bathtub and is indicated by the illuminated red LED.

Filling takes place through the jets from the bottom of the bathtub, and once it has finished the bathtub is filled.

After reaching the correct level, the system automatically stops the filling and makes available the functions of whirlpool, recirculation, ozone, and heater. During bathtub use, the system automatically maintains the water level equal to the edge of the bathtub.

Automatic filling using the keypad pressing the key activates the automatic filling of the bathtub, controlled by two level sensors and confirmed by the fixed blue key.

### CAPACITIVE GLASS KEYPAD M2/FD - 110V and 208-240V 50/60Hz HydroRelax and Spa Models with 1 Pump and Electronic Fill/Drain Function

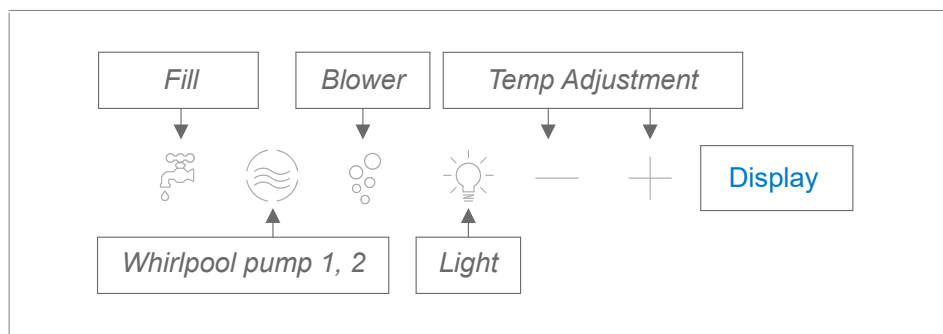

### Functionality summary:

Key	Function
Whirlpool pump/s	Configuration of two single-speed whirlpool pumps: 1st touch: P1 ON -> blinking blue light 2nd touch: P1 and P2 ON -> steady blue light 3rd touch: P1 OFF -> blinking blue light 4th touch: P1 and P2 OFF -> white light * (applies only if 2nd pump is installed)
Blower	Blower ON/OFF * (applies only to models with separate blower)
Fill (only if equipped with fill valve)	Touch and hold for 3s - Fill SV ON
Light	Chromotherapy: One touch: start colour sequence Repeated touches: change/set colour manually Touch and hold for ≤ 3s: OFF
- / + Key	Temperature adjustment



### DRAIN AND SUCTION INLET

The bathtub drain is positioned on the bottom, hidden by the finishing plate.

This solution makes the use of the bathtub safer and more comfortable.

To clean the drainage grate, just manually remove the finishing plate since it is simply resting on the bottom.

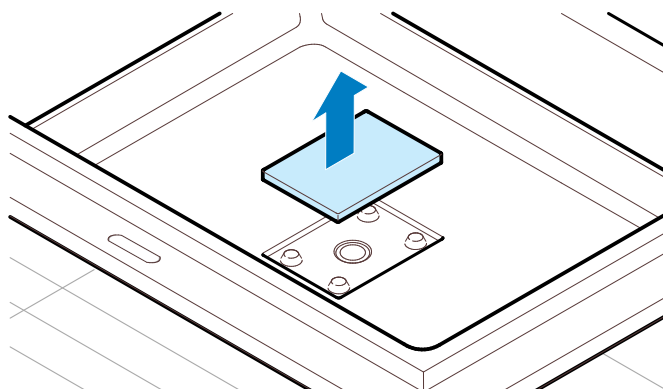

### WHIRLPOOL

This bathtub is equipped with the patented concealed therapy channel, which allows for very minimalistic and aesthetically pleasing hydromassage bathtub design.

The concealed therapy channel hosts large number of jets and LED lightning system.

Moreover, a very powerful hydromassage effect is achieved by mixing forced air and water from the hydromassage pumps.

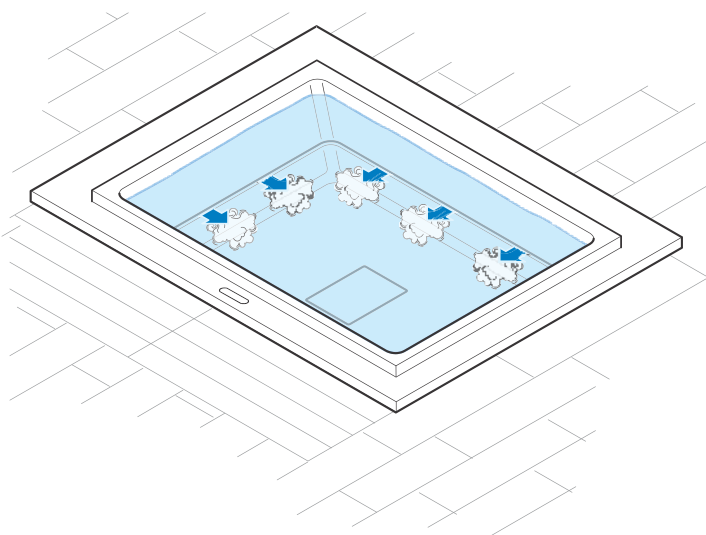

### CHROMOTHERAPY

This bathtub is equipped with the patented concealed therapy channel, which allows for very minimalistic and aesthetically pleasing hydromassage bathtub design.

The concealed therapy channel hosts large number of jets and LED lightning system.

Moreover, a very powerful hydromassage effect is achieved by mixing forced air and water from the hydromassage pumps.

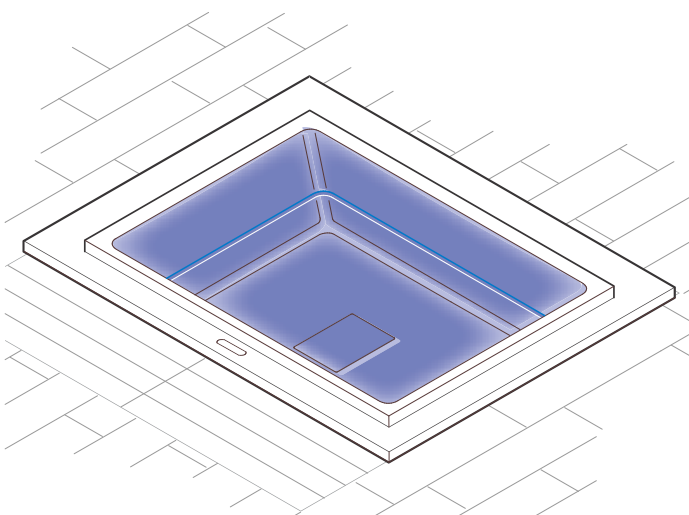

# Fusion & Dream Series Bathtub

## Operating Manual

### OVERFLOW EDGE

The overflow edge of the bathtub collects excess water and conveys it to the collection tanks under the bathtub. The water level is always constant, allowing for relaxation and total wellness experience.

The water that overflows is recovered, filtered and automatically recirculated within the bathtub through the intake grille.

 The bathtub works exclusively when the bathtub and tanks are full of water.

 The edge is designed to recover the overflowing water, not for abnormal movements caused by the improper use of the bathtub (e.g., diving).

In this regard, we strongly recommend entering the bathtub and getting in the water slowly.

When the recirculation of the water overflow is active, the heater automatically activates to manage the water temperature.

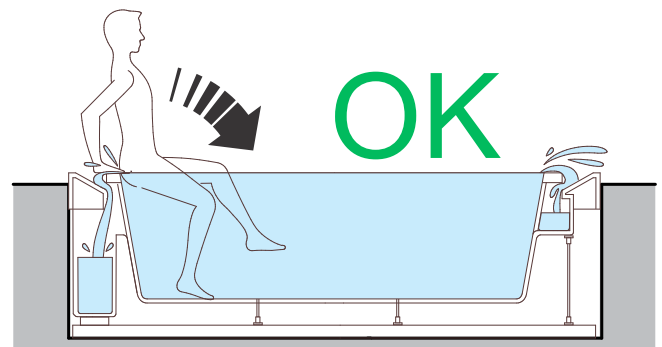

### CONTROL PANEL: HOW TO USE IT

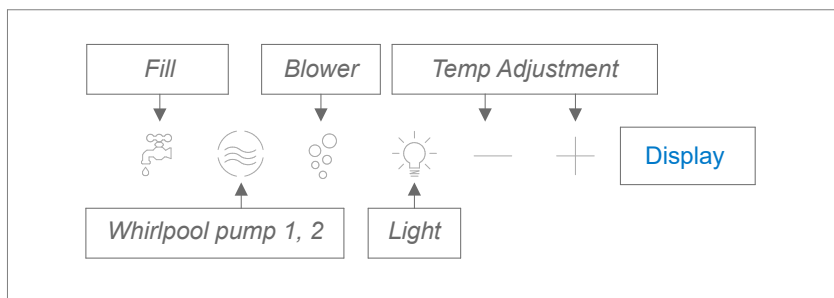

CAPACITIVE GLASS KEYPAD M2/FD - 110V and 208-240V  
50/60Hz HydroRelax and Spa Models with 1 Pump and  
Electronic Fill/Drain Function  
(\*2nd pump might or might not be installed)

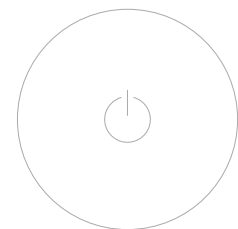





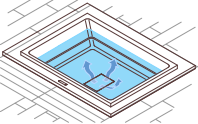

Bathtub drain key  
White - inactive;  
Blue - draining in progress

Functionality summary:

Key	Function
Whirlpool pump/s	Configuration of two single-speed whirlpool pumps: 1st touch: P1 ON -> blinking blue light 2nd touch: P1 and P2 ON -> steady blue light 3rd touch: P1 OFF -> blinking blue light 4th touch: P1 and P2 OFF -> white light * (applies only if 2nd pump is installed)
Blower	Blower ON/OFF * (applies only to models with separate blower)
Fill (only if equipped with fill valve)	Touch and hold for 3s - Fill SV ON
Light	Chromotherapy: One touch: start colour sequence Repeated touches: change/set colour manually Touch and hold for ≤ 3s: OFF
- / + Key	Temperature adjustment

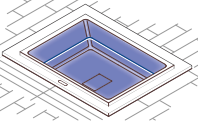
Basic functions:

Function	Description
Power ON	The bathtub is powered on by connecting it to the mains. At power ON all the LEDs/keys light up for three seconds, then the version (Fxx, e.g., F01) and firmware revision (ryy, e.g., r05) are displayed.
Filling 	The bathtub is filled by pressing the key: Filling in progress is indicated by the fixed blue key.  Filling takes place through the jets from the bottom of the bathtub, and once it has finished the bathtub is filled. Upon reaching the correct level, the system will automatically stop the filling process and enable bathtub functionality like hydromassage, circulation, heating. During bathtub use the system automatically maintains the water level equal to the edge of the bathtub.
Emptying	The bathtub is emptied by pressing the key: Emptying in progress is indicated by the flashing blue key. 
Whirlpool	The whirlpool is started by pressing the key: 
Chromotherapy 	Chromotherapy is started by pressing the "Light" key.  Activates a sequence of 16 colours that vary in an automatic sequence.* During the sequence, pressing the "Light" key again stops on the current colour (e.g., Red): the sequence is interrupted and remains fixed on the chosen colour. If you want to change this colour, by repeatedly pressing the "Light" key you can run through all the colours to choose a different one. Once you have selected a fixed colour, to return to the automatic sequence you must turn off and reactivate the function. Hold the "Light" key for two seconds to turn off the function. If not switched off manually, the function stops automatically after three hours. The function can always be activated, even if the water level is low. *Colour sequence: White, Red, Orange, Yellow 1, Yellow 2, Yellow 3, Green 1, Green 2, Green 3, Blue 1, Blue 2, Blue 3, Blue 1, Blue 2, Blue 3, Purple.... White, Red, etc.

# *Fusion & Dream Series Bathtub*

## Operating Manual

### MOST COMMON ERROR MESSAGES

**AL1** - The bathtub is empty or the water level is below the minimum level. All functions with exception of the Light function (whirlpool pumps, blower, circulation pump, heater and ozonator) are disabled. Solution - fill you bathtub with water.

#### **LL - Low water level**

If water is not detected by the level sensor for more than 3 seconds continuously, a low water level alarm is tripped. All functions with exception of the Light function (whirlpool pumps, blower, circulation pump, heater and ozonator) are disabled, and the message "LL" appears in the display, alternating with the temperature. The alarm resets automatically once the correct water level is restored.

#### **Automatic Air System Purge Mode**

This function activates automatically when water has been detected by the level sensor for at least 2 minutes and then not detected for at least 12 minutes (in this situation the display will show LL/temperature in alternation, and the blower icon blinks). Blower activates for 2 minutes with icon permanently illuminated.

#### **Abnormally high temperature**

If the water temperature rises above 42 °C (107F), all functionality will be disabled, and the message "HI" will appear on the display, alternating with the temperature.

The alarm resets automatically and the functionality will be re-enabled once the temperature drops to  $\leq 40^{\circ}\text{C}$  ( $\leq 104\text{F}$ ).

